



KJ'S EDUCATIONAL INSTITUTE



TRINITY ACADEMY OF ENGINEERING

Approved by AICTE, Affiliated to Savitribai Phule Pune University

Accredited by NAAC 'A' Grade



DTE CODE: EN 6634

110 ACRES OF BEAUTIFUL CAMPUS

Project Based Learning Booklet





KJ's Educational Institute
TRINITY ACADEMY OF ENGINEERING,PUNE

(Approved by AICTE, New Delhi, Govt. of Maharashtra & affiliated to SPPU, DTE Code: EN6634)

(Accredited by NAAC with 'A' Grade)

Department of Information Technology

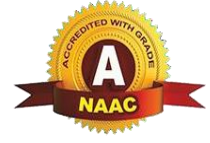

Group No :: 1

**TITLE OF PBL PROJECT: Student Result Analysis and Performance
ReportGenerator**

Details of Group Member:

Sr.No.	Name of student	Rollno	Mobile no.	Email id	Guide Name
1	Gaurav Kakad	26	7798592951	Gauravkakad2468@gmail.com	Mrs.P. R.Patil Sign:
2	Nikita Khupse	32	9156492810	khuspsenikita@gmail.com	
3	Rohit Shilimkar	49	7028786468	rrshilimkar@gmail.com	
4	Vaibhav Raut	47	9325499299	Rautvaibhav901@gmailcom	
5	Alfarha Shaikh	48	7972924970	Alfarhashaikh.tae@kjei.edu.in	

Abstract:

This system describes the development and implementation of the student result analysis and performance report generator used in generating academic report. The existing systems are time consuming, non-user friendly, creating and managing the file for data extraction is manual which is complex to use for user. Our software is designed to automate the process of analyzing and processing academic results in educational institutions. The report provides an overview of the software's features, including its ability to generate statistical reports, analyze patterns in student performance, and identify areas for improvement. the software is user-friendly and customizable, with a simple and intuitive interface that allows users to input and access data easily. The report also Outlines the development process, including the methodology and tools used for design and testing, as well as the challenges faced during the development process. This process involves converting pdf into excel and performing different operations on that particular excel sheet to display out specifics like toppers, failed students, subject wise assessment using tables as well as graphs to help visualizing the data.

Keyword: Analysing, Statistical, Customization, Automation,



Student Result Analysis and Performance Report Generator

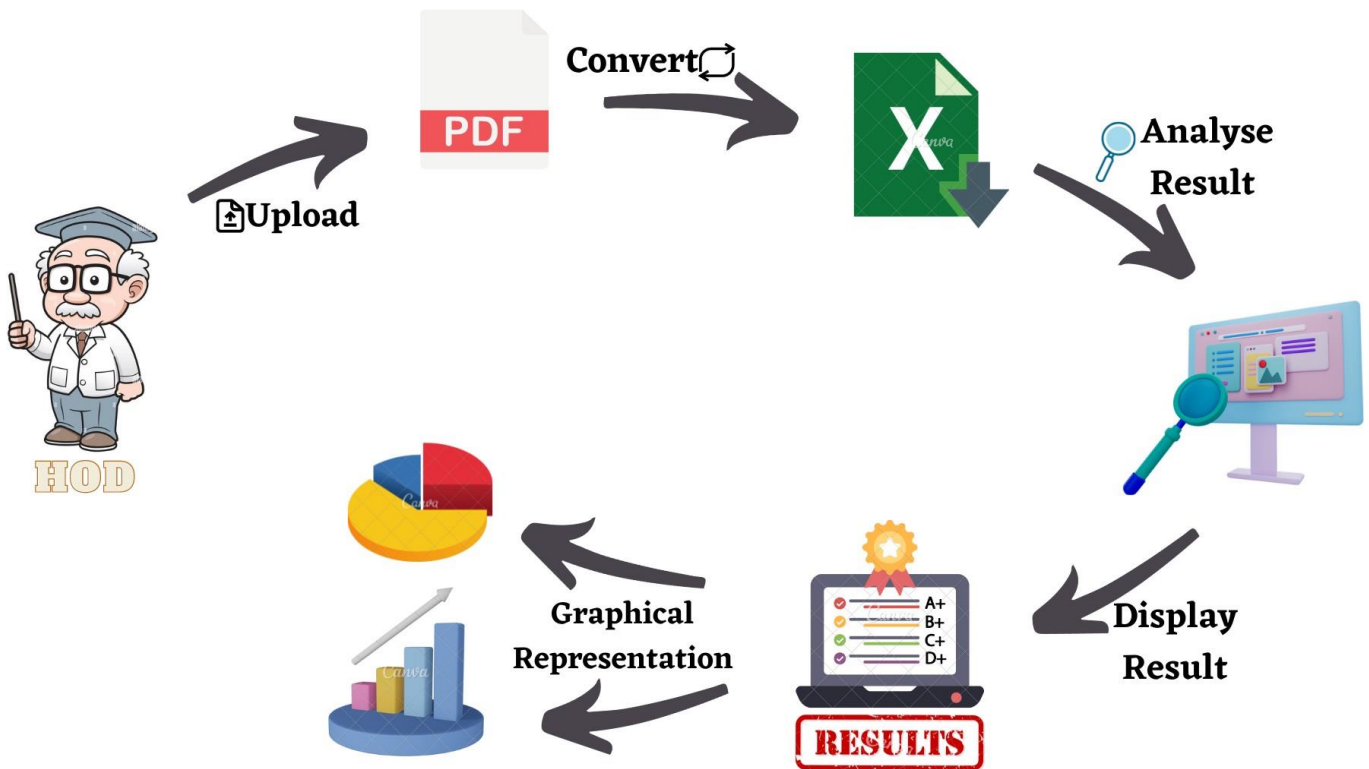



KJ's Educational Institute
TRINITY ACADEMY OF ENGINEERING, PUNE
(Approved by AICTE, New Delhi, Govt. of Maharashtra & affiliated to SPPU, DTE Code: EN6634)



(Accredited by NAAC with 'A' Grade)
Department of Information Technology

Group No :: 2

TITLE OF PBL PROJECT: Efficient Parking Management System

Details of Group Member:

Sr.No.	Name of student	Rollno	Mobile no.	Email id	Guide Name
1	Om Awari	02	8459971969	asmitawari@gmail.com	Ms S.N. Maitri Sign:
2	Priyanka Bangale	03	9529149282	Bangalepriyanka199@gmail.com	
3	Yash Chandan	07	8788388620	Yashparaschandand3@gmail.com	
4	Sushant Daphare	14	7499216483		

Abstract:

Parking shortages is a common problem in today's era that we all know specially faced by College and Universities. And one of the major solutions is to equip these existing parking lots with smart parking system. While various smart parking system have been developed to provide parking monitoring and guidance, the central problem is how to make the trade of between the cost, accuracy and reliability. In this project we present our system that integrates IOT sensor and surveillance cameras to count vehicle at parking structure. The Vehicle Parking Management System (VPMS) is a system that enables customers/drivers to reserve a parking space. It also allows the customers/drivers to view the parking status. It was developed because the congestion and collision of the vehicle, the system was developed for parking vehicles at KJEI campus. Therefore, the project aimed at solving such problems by designing a web-based system that will enable the customers/drivers to make a reservation of available parking space at Campus. These requirements were later used to design the system by creating data flow diagrams and entity relationship



KJ's Educational Institute
TRINITY ACADEMY OF ENGINEERING, PUNE

(Approved by AICTE, New Delhi, Govt. of Maharashtra & affiliated to SPPU, DTE Code: EN6634)

(Accredited by NAAC with 'A' Grade)

Department of Information Technology



diagrams. The designed system was implemented using different development tools which include HTML for creating interfaces, CSS for styling web pages for dynamism in the webpages and as an input validation tool. XAMMP was used to build the database and PHP used as a server-side scripting language to connect the user interfaces to the database.

Keyword: Parking system, Reservation, Interface, Database, XAMMP, HTML & CSS, IOT

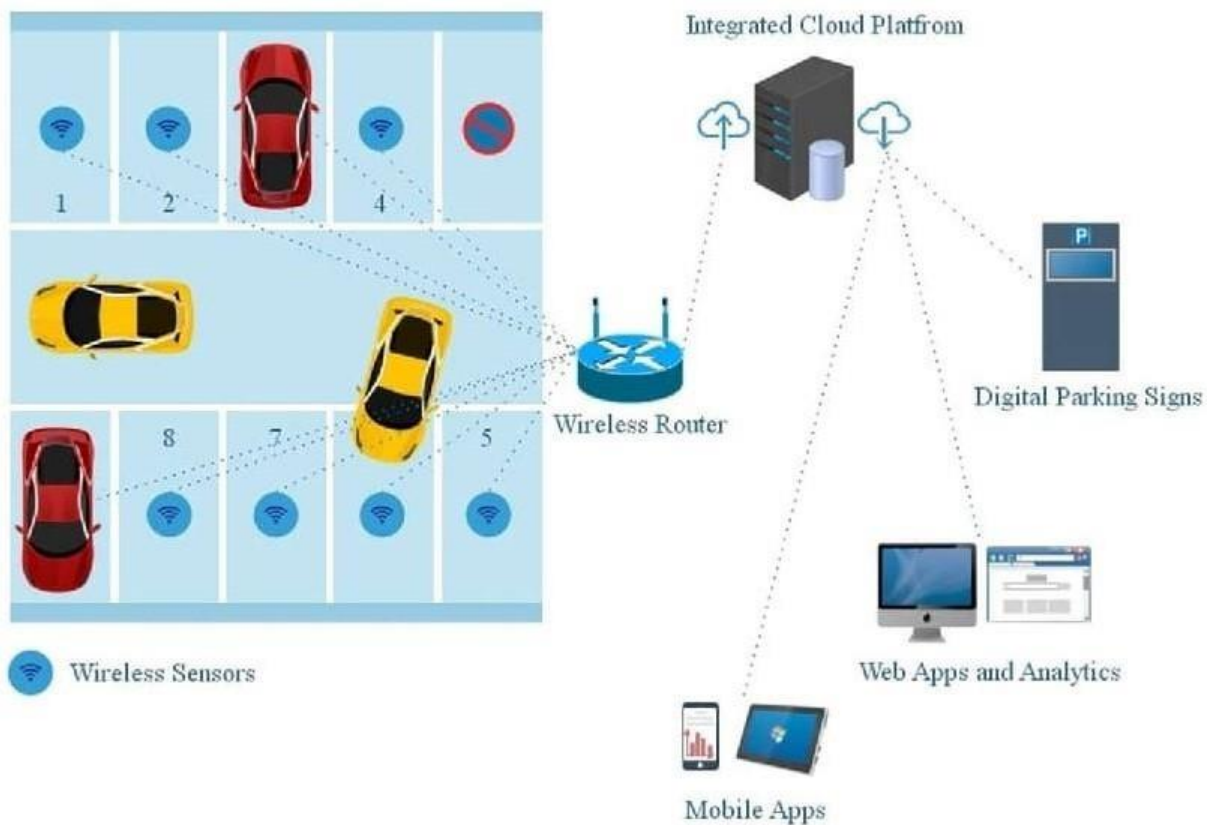



KJ's Educational Institute
TRINITY ACADEMY OF ENGINEERING, PUNE

(Approved by AICTE, New Delhi, Govt. of Maharashtra & affiliated to SPPU, DTE Code: EN6634)

(Accredited by NAAC with 'A' Grade)

Department of Information Technology



Group No :: 3

TITLE OF PBL PROJECT: Feedback Management and Analysis

Details of Group Member:

Sr.No.	Name of student	Rollno	Mobile no.	Email id	Guide Name
1	Varun Kakapuri	27	7507770069	varun.kakapuri@gmail.com	Ms S.N. Maitri Sign:
2	Urvashi Phadatare	45	8767325161	phadatareurvashi@gmail.com	
3	Sanika Kolate	33	9527373624	kolatesanika7@gmail.com	
4	Vaibhav Palve	39	8830581591	palve05@gmail.com	
5	Omkar Patil	40	9657002525	omkarpatil5574zz@gmail.com	

ABSTRACT: The project “Feedback Management and Analysis System” aims to develop a cross-platform application for Trinity Academy of Engineering using Flutter and Firebase technologies. The application will provide a user-friendly interface for students, faculty, and staff to submit feedback on various aspects of the college anonymously. The primary goal of the system is to collect feedback from stakeholders in a secure and anonymous manner, allowing users to express their opinions without fear of repercussion. The application will allow users to provide feedback on various topics such as faculty performance, infrastructure, curriculum, extracurricular activities, and more.

The proposed project will benefit Trinity Academy of Engineering by providing a comprehensive and anonymous feedback collection system that will help improve the quality of education and campus experience. Additionally, the project will demonstrate the use of modern technologies such as Flutter and Firebase in building cross-platform applications, which can be a valuable learning resource for students interested in app development.

Keyword: Multi-platform application, Anonymous Feedback, Flutter framework, .Firebase integration



KJ's Educational Institute TRINITY ACADEMY OF ENGINEERING, PUNE

(Approved by AICTE, New Delhi, Govt. of Maharashtra & affiliated to SPPU, DTE Code: EN6634)

(Accredited by NAAC with 'A' Grade)

Department of Information Technology

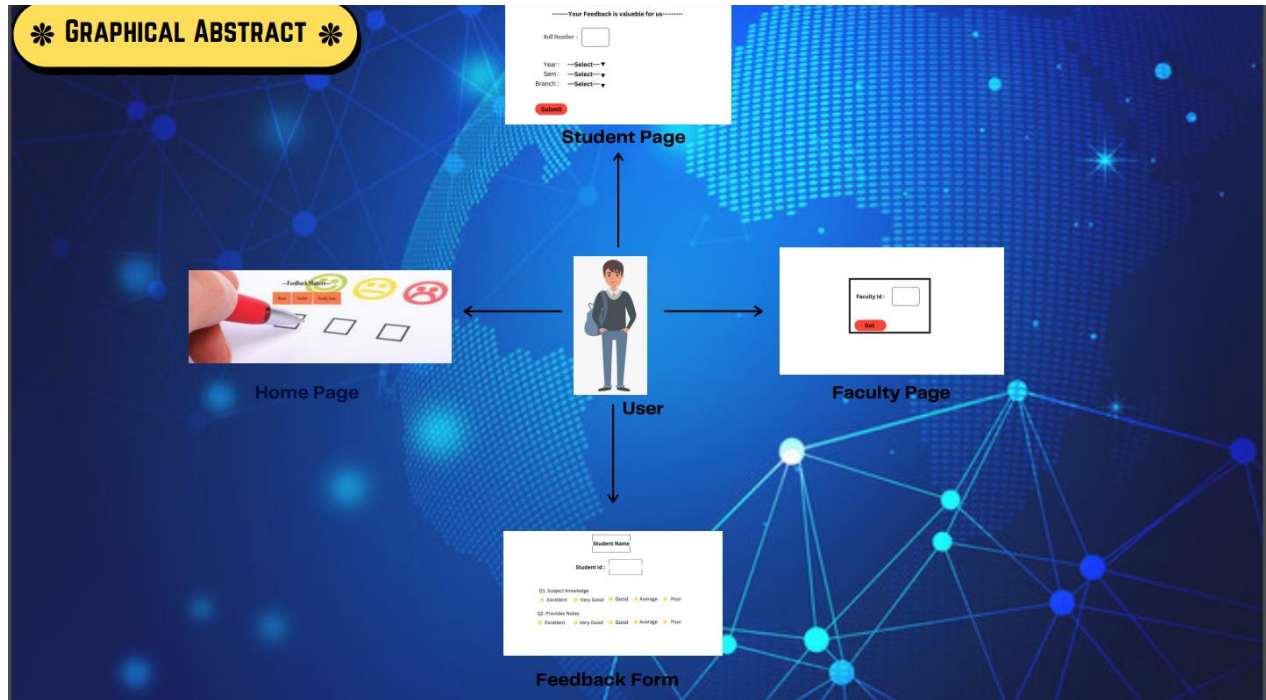



KJ's Educational Institute
TRINITY ACADEMY OF ENGINEERING, PUNE

(Approved by AICTE, New Delhi, Govt. of Maharashtra & affiliated to SPPU, DTE Code: EN6634)

(Accredited by NAAC with 'A' Grade)

Department of Information Technology

Group no:: 4



TITLE OF PBL PROJECT: Machine Learning Techniques for Spam Detection In E-Mails

Details of Group Member:

Sr.No.	Name of student	Rollno	Mobile no.	Email id	Guide Name
1	Bari Roshan A.	04	9764290772	roshanbari2002@gmail.com	Ms S.N. Maitri Sign:
2	Burkule Vaibhavi D.	06	87676 29501	vaibhaviburkule64@gmail.com	
3	Chaudhari Jatin L.	09	86982 63315	jatinlc1919@gmail.com	
4	Doltade Rohan M.	18	99604 51150	doltaderohan@gmail.com	
5	Done Manik A.	19	84592 55811	manikdone6039@gmail.com	

Abstract:

Nowadays, emails are used in almost every field. Emails have two subcategories, i.e., ham and spam. Email spam, also called unwanted emails, is a type of email that can be used to harm any user by stealing valuable information. The spam emails are increasing rapidly day by day. Spam detection and filtration are significant and enormous problems for email providers. Already every e-mail service provider has spam email detection but still its accuracy is not that much. Sometimes they classify useful emails as spam. Among all the techniques developed for detecting and preventing spam, filtering emails is one of the most essential and prominent approaches. Machine learning and deep learning techniques have been used for this purpose. The model will use a combination of feature extraction and classification algorithms to accurately identify spam emails and flag them for users. This project aims to classifying them into suitable categories using machine learning techniques for spam filtering in email. These techniques are also made based on accuracy, precision, recall, etc.

Keyword: Machine Learning, Deep Learning, Email Spam, Cyber Security, Filtration

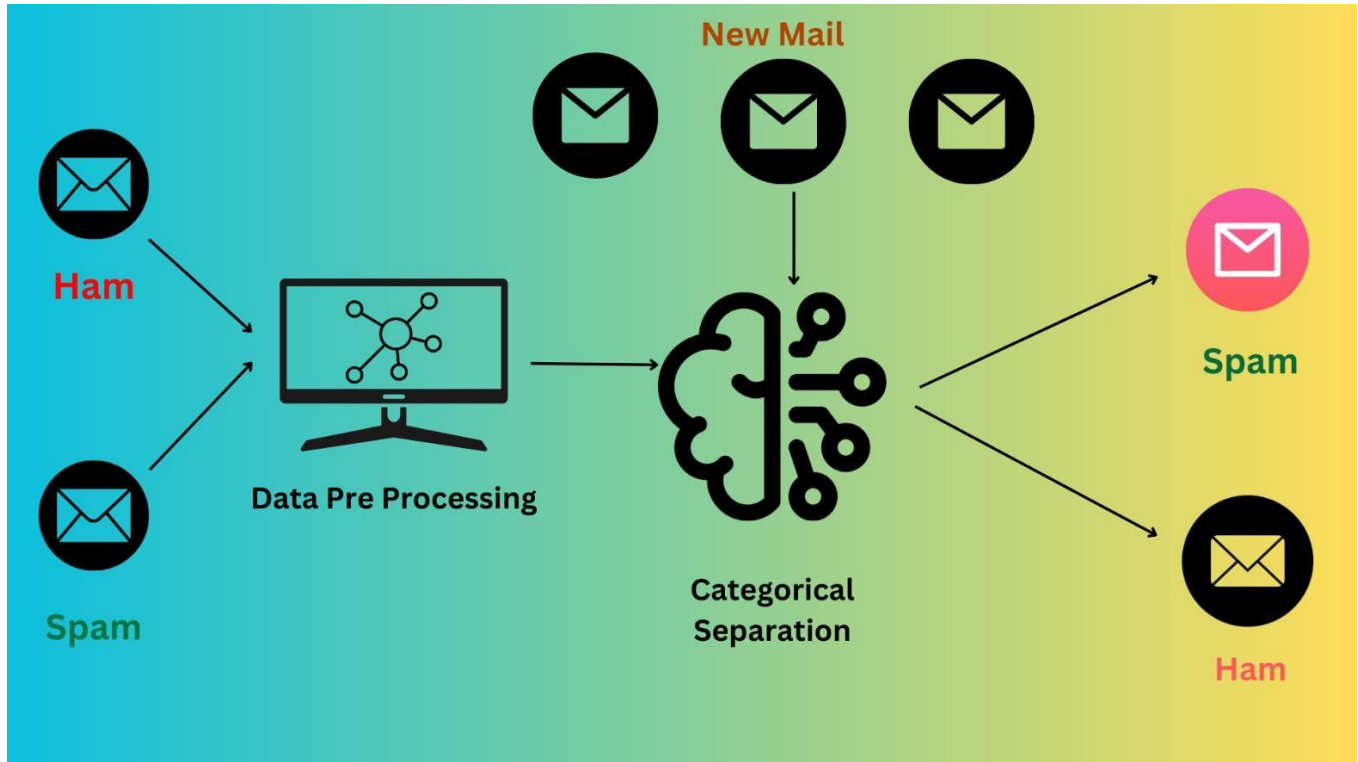

Gra



KJ's Educational Institute
TRINITY ACADEMY OF ENGINEERING,
PUNE



(Approved by AICTE, New Delhi, Govt. of Maharashtra & affiliated to SPPU, DTE Code:
EN6634)

(Accredited by NAAC with 'A' Grade)

Department of Information Technology

Group No :: 5

TITLE OF PBL PROJECT: Carbon Footprint Reduction Dashboard

Details of Group Member:

Sr.No.	Name of student	Rollno	Mobile no.	Email id	Guide Name
1	GVijaychandra	61	8329647408	vijaychandra20038@gmail.com	Mrs.P. R. Patil Sign:
2	Barbade Vaishnav	74	9370472960	vaishnavpatil1143@gmail.com	
3	Anis Shaikh	65	9175646370	shk.aniss@gmail.com	
4	Tarique Shaikh	64	8149285502	tariqueshaikh933@gmail.com	

Abstract:

A carbon footprints dashboard is a tool that provides information about the number of carbon emissions produced by an individual, organization, or a country in the form of visualizations and data analytics. Carbon emissions are typically associated with human activities such as transportation, energy use, and industrial production that can be calculated in terms of carbon dioxide equivalents. Using the datasets containing country wise carbon emissions, electricity and meat consumption, transportation, etc. we can show data visualizations pertaining to the carbon footprints. By monitoring and analyzing data over time, we can identify areas where emissions can be reduced and develop strategies to achieve their carbon reduction goals. The dashboard may include features such as charts, graphs, and data visualizations that display energy consumption, transportation, and waste reduction metrics.

Keyword: carbon footprint, data visualizations, data analysis, dashboard, country-wise dataset, carbon reduction.



KJ's Educational Institute
TRINITY ACADEMY OF ENGINEERING,
PUNE



(Approved by AICTE, New Delhi, Govt. of Maharashtra & affiliated to SPPU, DTE Code: EN6634)

(Accredited by NAAC with 'A' Grade)

Department of Information Technology

PURPOSE :
Carbon Footprint
Reduction Dashboard

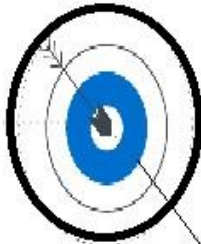

LAYOUT :
Designing the
dashboard

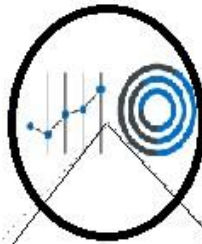

FINAL PRODUCT :
Completion of
Dashboard



TRANSFORM :
Find appropriate dataset
and make necessary changes



VISUALIZATIONS :
Adding visualizations

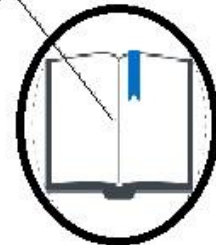

PUBLISH :
Deploying the
dashboard

Graphical Abstract



KJ's Educational Institute
TRINITY ACADEMY OF ENGINEERING,
PUNE



(Approved by AICTE, New Delhi, Govt. of Maharashtra & affiliated to SPPU, DTE Code:
EN6634)

(Accredited by NAAC with 'A' Grade)

Department of Information Technology

Group No :: 6

**TITLE OF PBL PROJECT: To design accurate, efficient,
sustainable, and personalized house plans using machine learning
algorithm.**

Details of Group Member:

Sr.No.	Name of student	Rollno	Mobile no.	Email id	Guide Name
1	Vairat Pratik	57	7620197897	pratikvairat30@gmail.com	Ms S.N. Maitri Sign:
2	Rajpurohit Priyanka	62	9928773100	priyankarajpurohit3100@gmail.com	
3	Tandel Smit	54	9104559375	smittandel2301@gmail.com	
4	Yadav Piyush	58	7039752716	yadavpiyush1214@gmail.com	
5	Gavhane Siddhi	67	7517809607	siddhigavhane09@gmail.com	

Abstract:

In the early days of traditional architecture, most of the work was done through the paper and pencil method. This was a pretty lengthy and time-consuming process. The project aims to study issues in the preconstruction stage and provide a solution based on machine learning (ML) to reduce delay and inaccuracy problems in the design of house plans. The design of architectural house plans is a crucial process. It requires expertise in construction, architectural drawings, and, in the age of computers, a good command of CAD software. Also, when it comes to real-world construction projects, property owners may face issues simply due to a lack of proper planning. Not only this, but also in the preconstruction stage, design plans play a major role. One of the key points is that due to late approvals of house plans or a slow process of designing and taking reviews from house owners in the preconstruction stage, a major delay in construction happens. Also, this increases the cost of construction. Almost every field is being affected by modern technologies like AI and ML. This project aims to solve problems faced by homeowners in the design of house plans through AI and ML. Problems in the preconstruction stage can be solved by using the best AI and ML algorithms in the right



KJ's Educational Institute
**TRINITY ACADEMY OF ENGINEERING,
PUNE**



(Approved by AICTE, New Delhi, Govt. of Maharashtra & affiliated to SPPU, DTE Code: EN6634)

(Accredited by NAAC with 'A' Grade)

Department of Information Technology

way. With ML, the approval process can be fast. In this sense, machine learning provides the ability to analyse large datasets. Algorithms such as GAN can be used to design professional house plans, and CNN can help give the best plans to house owners as per their specifications while quickly processing the queries provided by them. This project ultimately aims to provide an interactive solution to homeowners and architects for design-related issues in the preconstruction stage.

Keyword: Neural Network, GAN, CNN, Machine Learning, Data Science.

Step 1: GAN Model

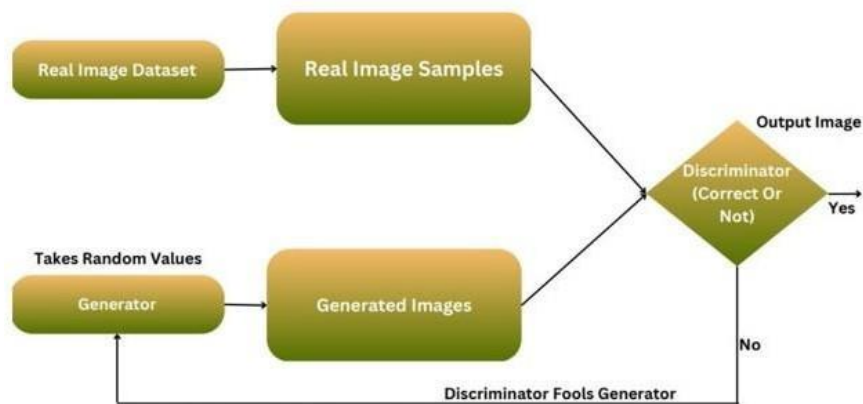

Step 2: CNN Model

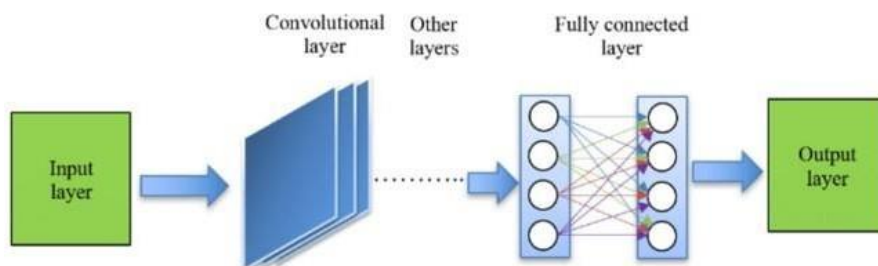



KJ's Educational Institute
TRINITY ACADEMY OF ENGINEERING,
PUNE



(Approved by AICTE, New Delhi, Govt. of Maharashtra & affiliated to SPPU, DTE Code:
EN6634)

(Accredited by NAAC with 'A' Grade)

Department of Information Technology

Group No :: 7

TITLE OF PBL PROJECT: E-Healthcare Management System

Details of Group Member:

Sr.No.	Name of student	Rollno	Mobile no.	Email id	Guide Name
1	Thevarkar Akash Shaharam	55	8767616492	athevarkar@gmail.com	Mrs.P. R. Patil Sign:
2	Thorat Om Sanjay	56	9834973053	omthorat4848@gmail.com	
3	Kumbhar Manasi Jaysing	72	7620201368	kumbharmanasi5@gmail.com	
4	Tarmode Shraddha Dayanand	73	9172403650	shraddhatarmode68@gmail.com	

Abstract:

Medical data are an ever growing source of information generated from hospitals consisting of patient records in the form of hard copies which can be made easier and convenient by using QR code of the patient details. Our aim is to build a Health-care Portal system which will provide the features like clinical management, patient records, disease prediction and generate QR code for every patient as per their updated disease information as well as if user has their any health insurance policy then through web application a company can add user's policy no to his account. Apart of that if user wants to search hospital or clinic according to his requirements he can search for the clinic with their facilities provided. For this study, we designed a QR Code Identity Tag system to integrate into the E-Health care system. Furthermore, we introduce the system accessing the medical information network by utilizing QR Identity Tag. The QR Code Identity Tag allows its members to be able to control their own Emergency Health Record such as carrying the information on themselves or editing them. We chose QR-code because it is a cost-efficient solution, which is of importance in developing countries.

Keyword: QR Code, E-Health, Emergency Health Record.



KJ's Educational Institute
**TRINITY ACADEMY OF ENGINEERING,
PUNE**



(Approved by AICTE, New Delhi, Govt. of Maharashtra & affiliated to SPPU, DTE Code:
EN6634)

(Accredited by NAAC with 'A' Grade)

Department of Information Technology

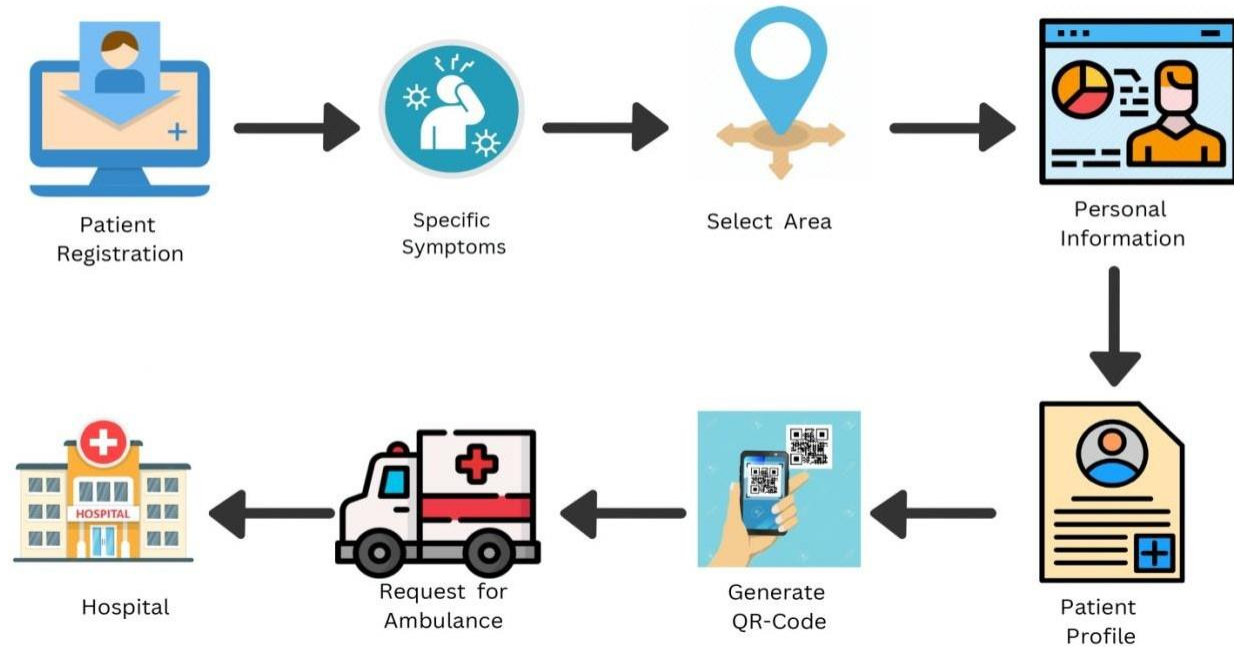



KJ's Educational Institute
TRINITY ACADEMY OF ENGINEERING,
PUNE



(Approved by AICTE, New Delhi, Govt. of Maharashtra & affiliated to SPPU, DTE Code:
EN6634)

(Accredited by NAAC with 'A' Grade)

Department of Information Technology

Group No :: 8

**TITLE OF PBL PROJECT: Prediction of Chronic Kidney Disease
Using Machine Learning.**

Details of Group Member:

Sr.No.	Name of student	Roll no	Mobile no.	Email id	Guide Name
1	Vedant Khapekar	30	9860955150	khapekarvedant@gmail.com	Prof. B.B. Desmukh Sign:
2	Ashwin Mote	36	7448144905	ashwinmote2003@gmail.com	
3	Sunil Patil	42	9172544420	sunilpatil7841@gmail.com	
4	Rajlaxmi Pawar	43	9284689928	pawarrajlaxmi77@gmail.com	

Abstract:

Chronic kidney disease (CKD) is a significant public health concern worldwide, and predicting its long-term progression is essential for effective management and prevention of complications. Various ML models and deep learning algorithms have been used to predict the long-term progression of CKD. These models use different features such as demographic data, clinical and laboratory measurements, and genetic information to predict the risk of progression to end-stage renal disease (ESRD). Several studies have reported high accuracy levels of up to 95% in predicting the long-term progression of CKD using ML models. ML models have also been used to identify the most critical features for CKD progression, such as baseline estimated glomerular filtration rate (eGFR), proteinuria, blood pressure, and age. Moreover, ML models have been used to develop personalized prediction models for CKD progression, taking into account individual risk factors and comorbidities. These personalized models have shown improved accuracy compared to traditional risk prediction models



KJ's Educational Institute
TRINITY ACADEMY OF ENGINEERING,
PUNE



(Approved by AICTE, New Delhi, Govt. of Maharashtra & affiliated to SPPU, DTE Code: EN6634)

(Accredited by NAAC with 'A' Grade)

Department of Information Technology

Keyword: Neural networks, clinical data, laboratory tests, blood pressure, glomerular filtration rate, family history, end-stage renal disease, long-term progression

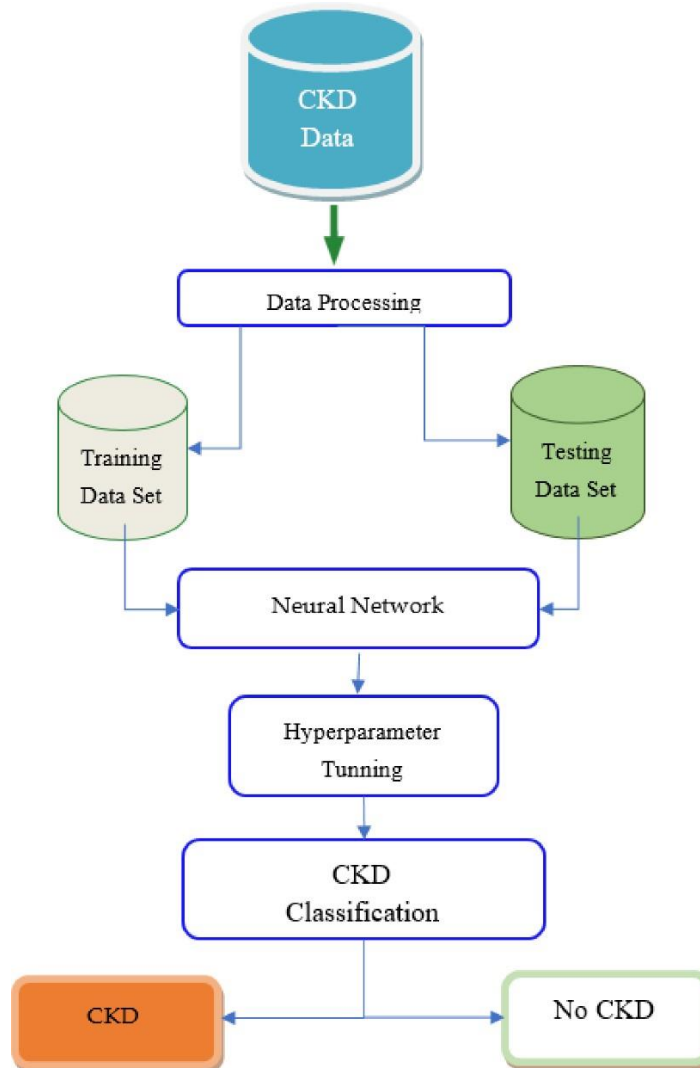



KJ's Educational Institute
TRINITY ACADEMY OF ENGINEERING,
PUNE



(Approved by AICTE, New Delhi, Govt. of Maharashtra & affiliated to SPPU, DTE Code:
EN6634)

(Accredited by NAAC with 'A' Grade)

Department of Information Technology

Group No :: 9

**TITLE OF PBL PROJECT: Campus Mart : A Second-hand Marketplace
for College Students.**

Details of Group Member:

Sr.No.	Name of student	Rollno	Mobile no.	Email id	Guide Name
1	Bhokare Aditya	05	8010936587	adityabhokare03@gmail.com	Ms S.N. Maitri Sign:
2	Dahitule Shubham	12	9529231213	shubhamdahitule1@gmail.com	
3	Dhenge Tanmay	15	8554889054	tanmaydhenge@gmail.com	
4	Dimble Abhay	16	9623487641	abhayajdimble@gmail.com	
5	Dolase Ajit	17	9112144663	ajdolase7588@gmail.com	

Abstract:

In today's world, students face numerous challenges while pursuing their education. Among them, the cost of textbooks and other college supplies can be a significant financial burden. Often, students are forced to buy expensive new textbooks, which they may only use for one semester, and then sell them back to the bookstore for a fraction of the cost. Additionally, students accumulate a lot of other items during their college years that they may no longer need or want, such as calculators, lab coats, and other supplies. To overcome this issue, our system used to create an online marketplace where students can buy and sell these items easily and affordably. The technology behind the platform will utilize a user-friendly interface and different features such as in-app messaging and payment processing to provide the best experience. **CampusMart** is a second-hand marketplace for college students. The platform is designed to



KJ's Educational Institute
**TRINITY ACADEMY OF ENGINEERING,
PUNE**



(Approved by AICTE, New Delhi, Govt. of Maharashtra & affiliated to SPPU, DTE Code:
EN6634)

(Accredited by NAAC with 'A' Grade)

Department of Information Technology

connect students on the same campus, making it easy for them to find the items they need at affordable prices. It offers a user-friendly interface that allows students to post items for sale quickly and efficiently, and to search for items they need with ease. By creating an online marketplace for students to buy and sell used items, we are promoting sustainability, community building, and financial savings for students. We believe that our project has the potential to make a significant impact on college campuses, and we look forward to bringing it to life.

Keywords: second-hand marketplace, environmentally conscious.



KJ's Educational Institute
TRINITY ACADEMY OF ENGINEERING,
PUNE



(Approved by AICTE, New Delhi, Govt. of Maharashtra & affiliated to SPPU, DTE Code:
EN6634)

(Accredited by NAAC with 'A' Grade)

Department of Information Technology

Group No :: 10

**TITLE OF PBL PROJECT: To Develop a solution for daily diet and
make health analysis easy**

Details of Group Member:

Sr.No.	Name of student	Roll no	Mobile no.	Email id	Guide Name
1	Raj Dattatray Gogawale	22	7620720066	Rajgogawale77@gmail.com	Mrs.Pratima Patil Sign:
2	Satyam Rajendra Chavan	11	9822799271	Chavansatyam9696@gmail.com	
3	Karuna Prakash Gole	23	9921519353	Karunagole624@gmail.com	
4	Arti Hanumant Chaudhari	8	9673201864	Chaudhariarti2146	
5	Vaishnavi Phulchchand Dapkar	13	8767637474	Vaishnavidapkar1@gmail.com	

Abstract:

In recent years, there has been a growing awareness of the importance of maintaining a healthy diet for overall well-being. With the proliferation of technology diet tracking websites have emerged as popular tools for individuals to monitor and manage their dietary habits. This feature enables users to gain a clear understanding of their eating habits, identify areas for improvement, and make informed decisions about their diet. In addition to tracking food intake, a diet tracking website also provides tools for monitoring nutrient intake. Users can view detailed nutrient breakdowns of their meals, such as protein, carbohydrates, fats, vitamins, and minerals. This information helps



KJ's Educational Institute TRINITY ACADEMY OF ENGINEERING, PUNE



(Approved by AICTE, New Delhi, Govt. of Maharashtra & affiliated to SPPU, DTE Code: EN6634)

(Accredited by NAAC with 'A' Grade)

Department of Information Technology

ensure they are getting a balanced and adequate intake of essential nutrients, and make adjustments to their diet as needed. Setting and achieving dietary goals is another key feature of a diet tracking website. Users can set personalized goals based on their specific dietary needs or health objectives, such as weight loss, muscle gain, Or managing a medical condition. The website provides progress tracking and reminders to help users stay on track and motivated towards achieving their goals.

Keyword: Health, Diet Tracking, Nutritional Analysis.

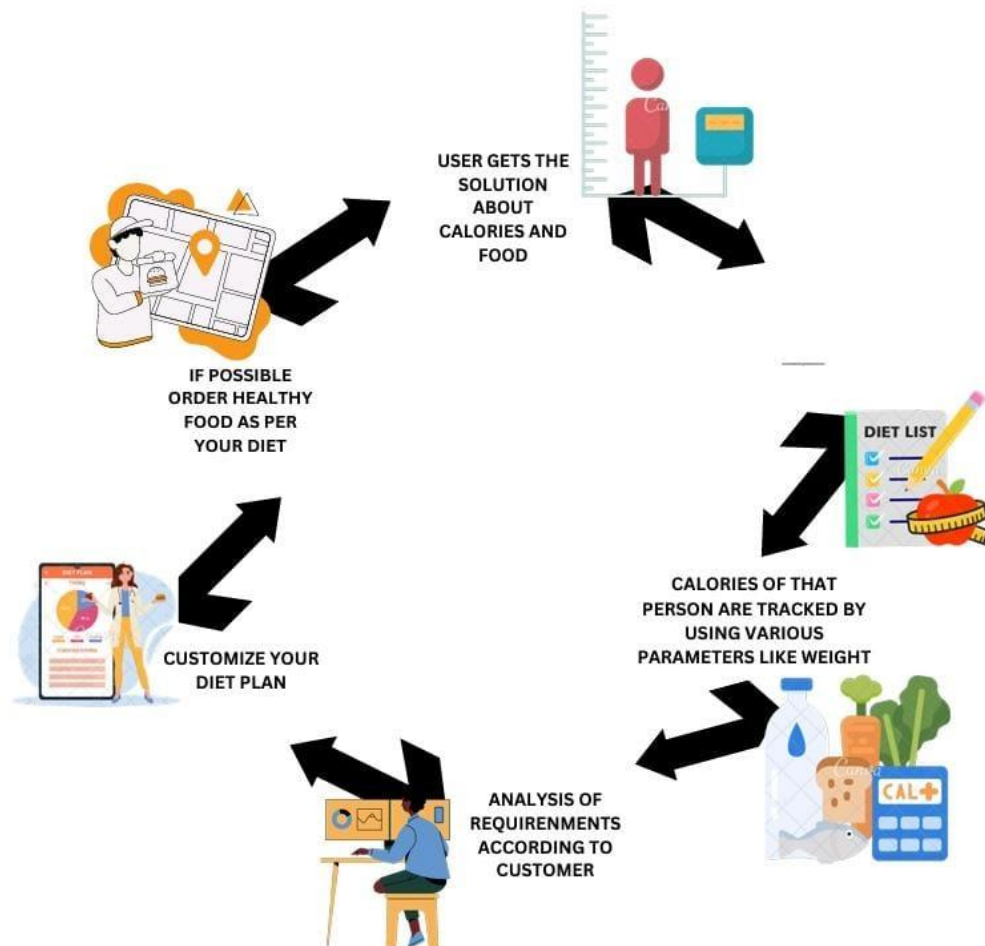



KJ's Educational Institute
TRINITY ACADEMY OF ENGINEERING,
PUNE



(Approved by AICTE, New Delhi, Govt. of Maharashtra & affiliated to SPPU, DTE Code:
EN6634)

(Accredited by NAAC with 'A' Grade)

Department of Information Technology

Group No :: 11

TITLE OF PBL PROJECT:

Details of Group Member:

Sr.No.	Name of student	Rollno	Mobile no.	Email id	Guide Name
1	Sakshi Ganesh Kandur	28	8087997396	sakshikandur004@gmail.com	Ms S.N. Maitri Sign:
2	Yash Narayan Karande	29	8208782260	ykarande15@gmail.com	
3	Vaishnavi Vijay Pawar	44	8767980311	vaishnavipawar5050@gmail.com	
4	Sadiya Shafik Mulani	37	7276301688	sadiyamulani4@gmail.com	
5	Omkar Dattatray Mane	35	9325511561	ommane8571@gmail.com	

Abstract:

Image scrapers can be used to collect data from websites that provide images, such as e-commerce websites, stock photo platforms, or image-sharing websites. This data can be used for various purposes such as market research, competitive analysis, or building image databases. An image scraper is a program or tool that automates the process of collecting images from the internet. It uses various techniques to extract images from websites, search engines, or social media platforms, and downloads them to a local storage or database. Image scrapers are commonly used for various purposes, such as data collection, content creation, or building image databases for machine learning applications. The main function of an image scraper is to search, locate, and download images from various online sources such as image hosting sites, social media platforms, search engine results, and other websites. The main purpose of the image scraper, which is to automate the process of collecting images from websites for various purposes such as data analysis, content creation, or image recognition.

Keyword: CBIR, DEEP LEARNING



KJ's Educational Institute
TRINITY ACADEMY OF ENGINEERING,
PUNE



(Approved by AICTE, New Delhi, Govt. of Maharashtra & affiliated to SPPU, DTE Code: EN6634)

(Accredited by NAAC with 'A' Grade)

Department of Information Technology

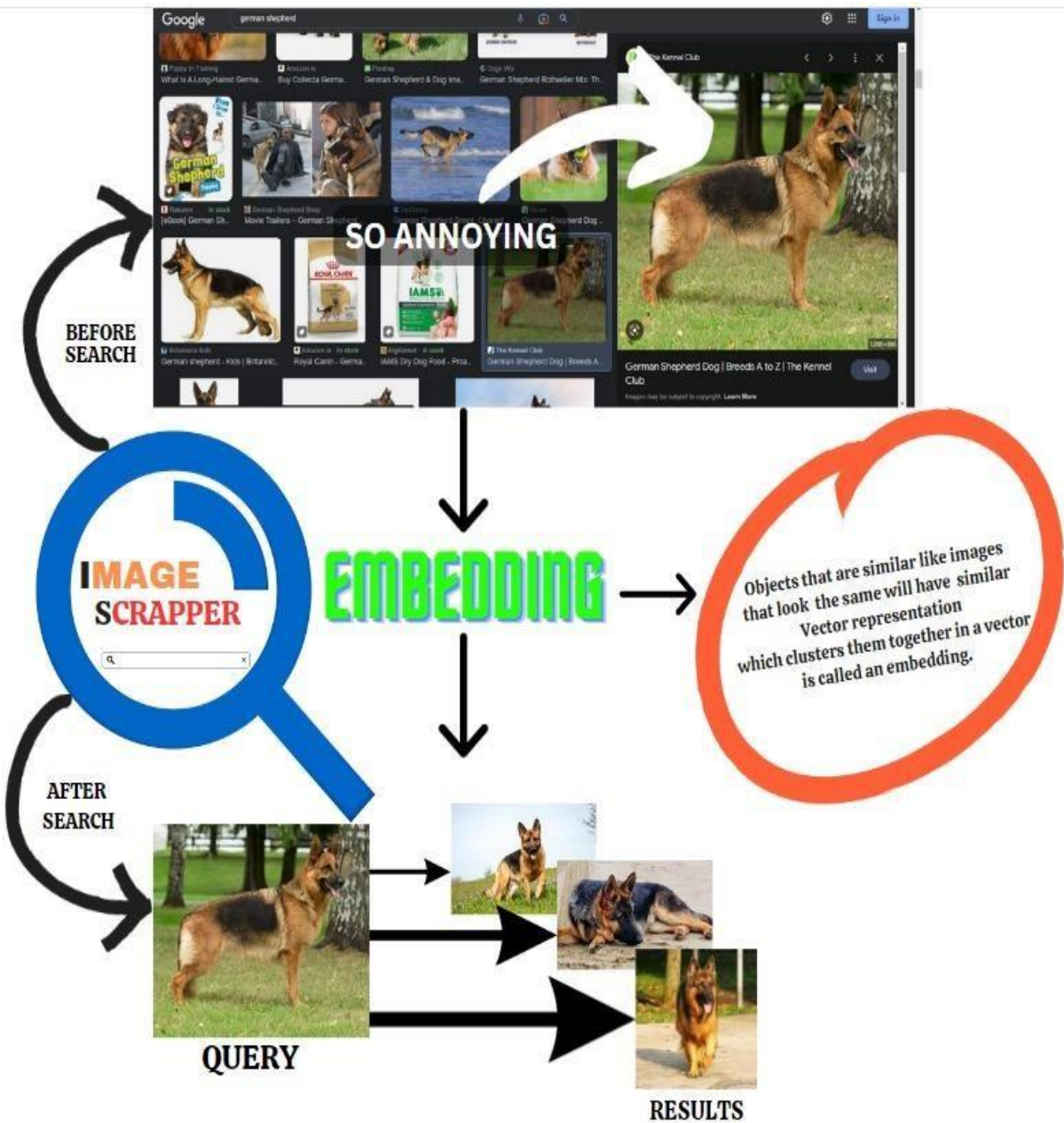



KJ's Educational Institute
TRINITY ACADEMY OF ENGINEERING,
PUNE



(Approved by AICTE, New Delhi, Govt. of Maharashtra & affiliated to SPPU, DTE Code:
EN6634)

(Accredited by NAAC with 'A' Grade)

Department of Information Technology

Group No :: 12

**TITLE OF PBL PROJECT: Happy Minds, Mental Health
App.**

Details of Group Member:

Sr.No.	Name of student	Rollno	Mobile no.	Email id	Guide Name
1	Jadhav Nikita Balasaheb	6fi	9370596903	nikitajadhav1229@gmail.com	Mrs.P. R.Patil Sign:
2	Kshirsagar Vishakha Vijay	69	7620013995	kshirsagarvishakha03@gmail.com	
3	Devne Mamta Satish	71	7263990671	mamtadevne23@gmail.com	
4	Mali Sakshi Bhagawat	75	7559255524	sakshimali082@gmail.com	

Abstract:

Today, Mental health includes our emotional, psychological, and social well-being. It affects how we think, feel, and act as we cope with life. It also helps us determine how we handle stress, communicate with others, and make choices. Our mental health is important because it adversely affects our physical health. Mental health apps have great potential to help people needing support to cope with stress, anxiety or specific symptoms. This system develop a free mental health app that take a mood survey every time you use it and returns music and blogs based on your current mood and at the end of the month. This was a never-done-before concept which could revolutionize mental health. The goal is to control mouse cursor functions with a simple camera rather than a traditional or standard mouse device. Using only a camera, the Virtual Mouse provides an infrastructure between the user and the machine. It enables the user to interact with a machine without the need for any mechanical or physical devices, and even allows to control mouse functions. This app is been coded in the Google's Android Studio which is a part of Android Open Source project. Mp Android chart is powerful in drawing chart. This App helps us to



KJ's Educational Institute
TRINITY ACADEMY OF ENGINEERING,
PUNE



(Approved by AICTE, New Delhi, Govt. of Maharashtra & affiliated to SPPU, DTE Code: EN6634)

(Accredited by NAAC with 'A' Grade)

Department of Information Technology

cope up with our mood and tracks our mood. A Data access object is being used which acts as a bridge between the user attempting to interact with the lower-level database.

HAPPYMINDS: MENTAL HEALTH APP



Notepad to write your emotions

Intensity of Feelings Words

EMOTION	Weak	Medium	Strong
Happy	Smiled	Grinned	Beamed
Surprised	Startled	Stunned	Flabbergasted
Angry	Furrowed	Scowled	Glared
Sad	Downcast	Downhearted	Dejected
Disappointed	Disheartened	Dispirited	Discouraged
Embarrassed	Flustered	Flummoxed	Flustered
Confused	Perplexed	Flummoxed	Flummoxed
Shocked	Stunned	Stunned	Stunned
Amazed	Stunned	Stunned	Stunned
Disgusted	Disgusted	Disgusted	Disgusted

Shows the intensity of your mood

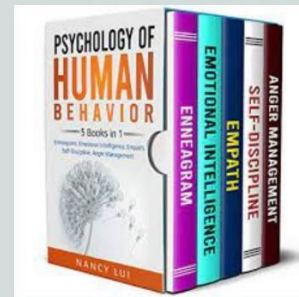

Suggests Articles related to your mood

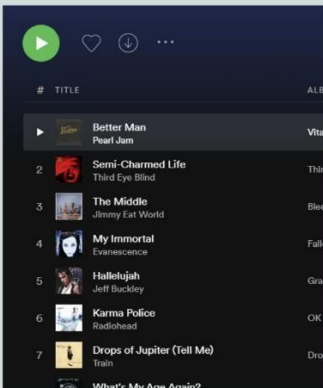

Suggests songs on Spotify on your Mood

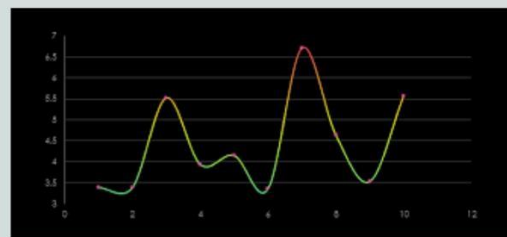

MPAndroid chat to show your mood

Keyword: Google's Android Studio, MP Android Chart, Mental Health Awareness, Data Access Object



KJ's Educational Institute
TRINITY ACADEMY OF ENGINEERING,
PUNE



(Approved by AICTE, New Delhi, Govt. of Maharashtra & affiliated to SPPU, DTE Code:
EN6634)

(Accredited by NAAC with 'A' Grade)

Department of Information Technology

Group No :: 13

TITLE OF PBL PROJECT: Library Management System

Details of Group Member:

Sr.No.	Name of student	Rollno	Mobile no.	Email id	Guide Name
1	Pratiksha Asundkar	01	89991 45892	pratikshaasundkar186@gmail.com	Mrs.P. R.Patil Sign:
2	Seema Chauhan	10	9322307228	chauhanseema1212@gmail.com	
3	Hasnain sayyed	24	98291 42620	hasnainsayyedkhan@gmail.com	

Abstract: The purpose of this project is to develop an application that will automate the whole procedure of a library. The software that would be developed should have facilities like Add / Delete Members, Add / Delete Books, Issue & Return. The application should be secured, as well as with limited access. The main requirement of the project will be the ease of use, besides being the most efficient and effective tool for the purpose. The application should be user friendly. It should be robust and scalable. An automated solution would be very beneficial to the organization, as it would bring structure to the whole process so that it can be traced for any kind of query. Also, an automated solution will lead to optimal utilization of the available resources, reducing duplication of effort, increasing efficiency and minimizing time-delays. Following are the main purpose of computerization:

To provide services to all the employees for issue, return & search etc. at one place.

To improve co-ordination in staff.

Keyword: To reduce paper filling work.



KJ's Educational Institute
**TRINITY ACADEMY OF ENGINEERING,
PUNE**



(Approved by AICTE, New Delhi, Govt. of Maharashtra & affiliated to SPPU, DTE Code:
EN6634)

(Accredited by NAAC with 'A' Grade)

Department of Information Technology

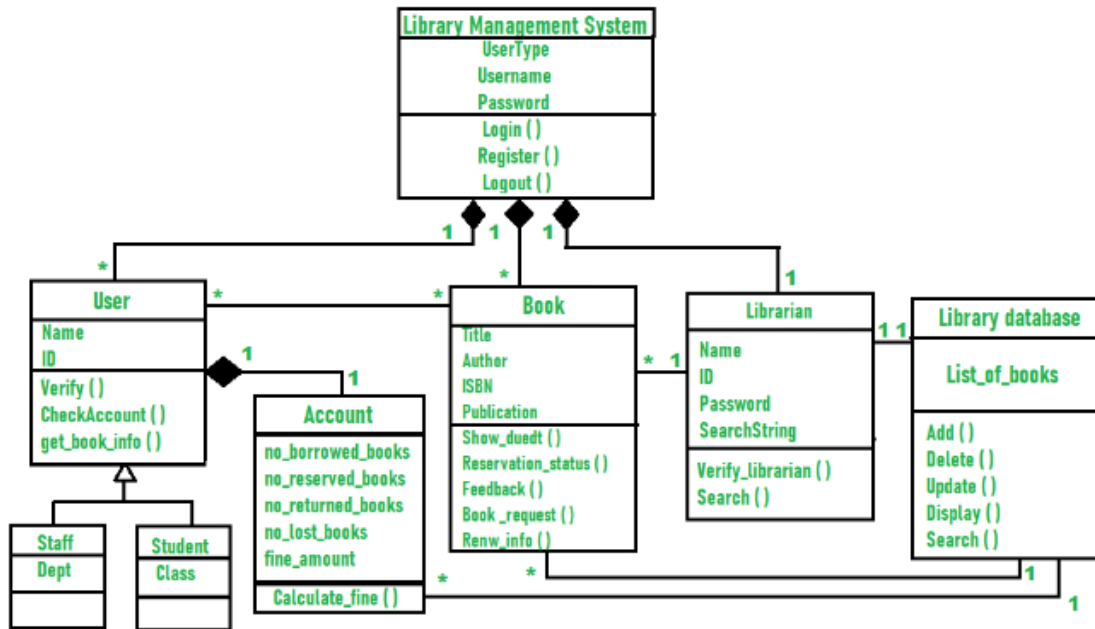



KJ's Educational Institute
TRINITY ACADEMY OF ENGINEERING,
PUNE



(Approved by AICTE, New Delhi, Govt. of Maharashtra & affiliated to SPPU, DTE Code:
EN6634)

(Accredited by NAAC with 'A' Grade)

Department of Information Technology

Group No :: 14

TITLE OF PBL PROJECT: Gas Leakage Indicator

Details of Group Member:

Sr.No.	Name of student	Rollno	Mobile no.	Email id	Guide Name
1	Shivam AnilGaikwad	21	7741861212	shivamgaikwad313@gmail.com	Prof. B.B. Desmukh Sign
2	Kunal Ranjeet Jagtap	25	7666707770	jagtap.kunal2000@gmail.com	
3	Nishant DnyaneshwarDongare	20	9359653277	piushdongare030303@gmail.com	

Abstract:

Liquefied Petroleum Gas (LPG) is a main source of fuel, especially in urban areas because it is clean compared to firewood and charcoal. Gas leakage is a major problem in the industrial sector, residential premises, etc. Nowadays, home security has become a major issue because of increasing gas

leakage. Gas leakage is a source of great anxiety with ateliers, residential areas and vehicles like

Compressed Natural Gas (CNG), buses, and cars which are run on gas power. One of the preventive methods to stop accidents associated with the gas leakage is to install a gas leakage detection kit at vulnerable places. The aim of this paper is to propose and discuss a design of a gas leakage detection system that can automatically detect, alert and control gas leakage. This proposed system also includes an alerting system for the users. The system is based on a sensor that easily detects a gas leakage.

Keyword: LPG (liquefied petroleum gas), gas sensor, buzzer (alarm), LED.



KJ's Educational Institute TRINITY ACADEMY OF ENGINEERING, PUNE



(Approved by AICTE, New Delhi, Govt. of Maharashtra & affiliated to SPPU, DTE Code: EN6634)

(Accredited by NAAC with 'A' Grade)

Department of Information Technology

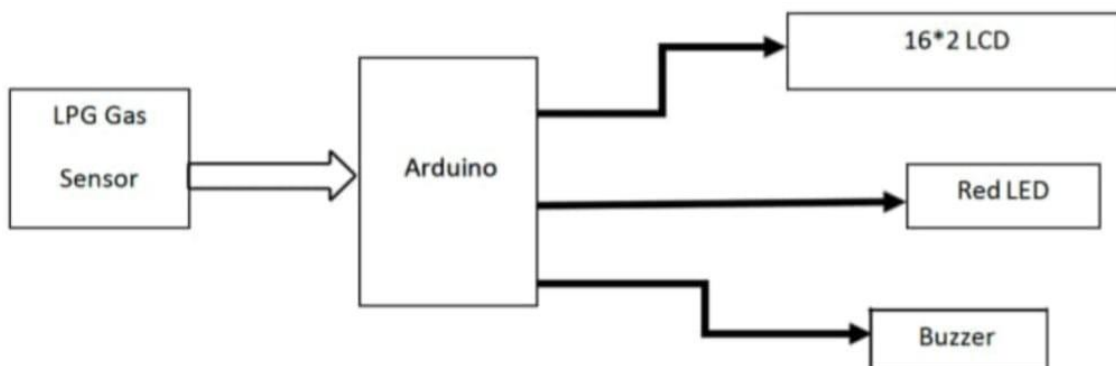
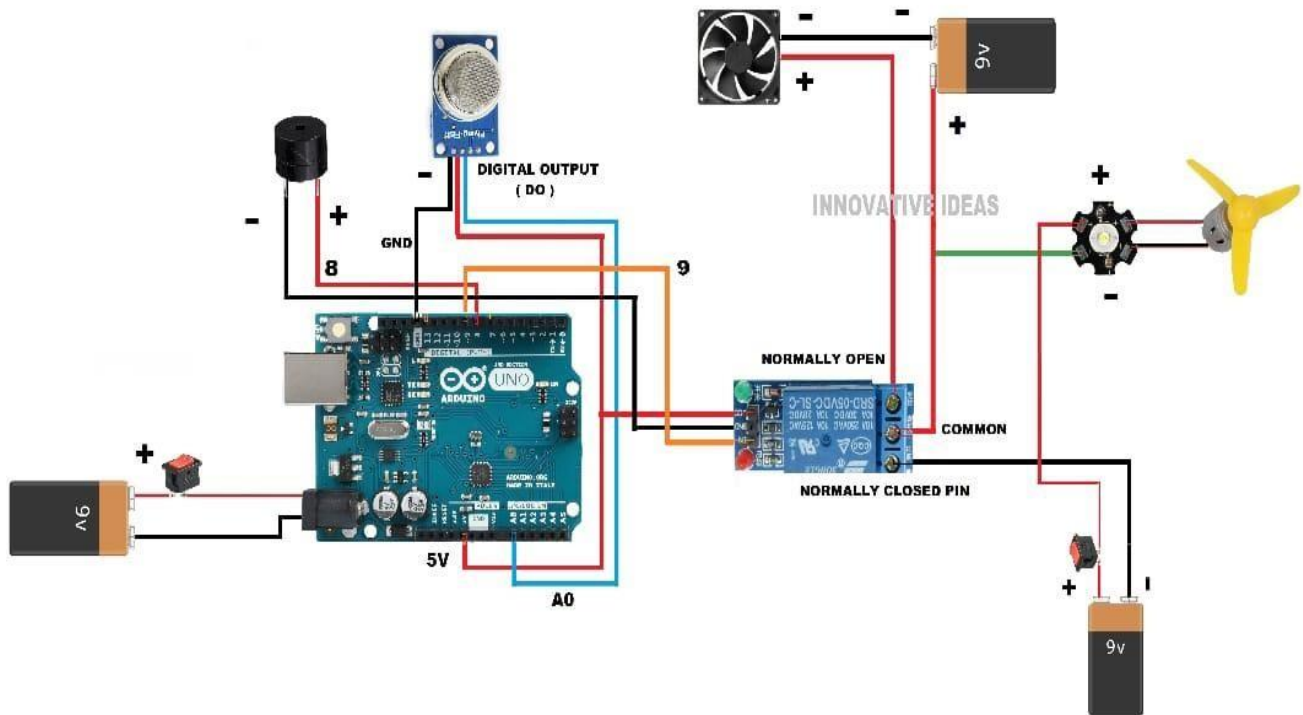

Figure 1. Block diagram of gas leakage detection and alert system.



KJ's Educational Institute
TRINITY ACADEMY OF ENGINEERING,
PUNE



(Approved by AICTE, New Delhi, Govt. of Maharashtra & affiliated to SPPU, DTE Code:
EN6634)

(Accredited by NAAC with 'A' Grade)

Department of Information Technology

Group No ::17

**TITLE OF PBL PROJECT: Data Analysis and Data Prediction on
Stock Market Using Machine Learning**

Details of Group Member:

Sr.No.	Name of student	Rollno	Mobile no.	Email id	Guide Name
1	Gorad Tanmay Pradeep	70	9767929913	tanmaygorad2@gmail.com	Prof. B.B. Desmukh Sign
2	Bhalerao Riddhi Mahesh	63	9359710151	riddhibhalerao8@gmail.com	
3	Zende Tejas Sunil	59	7350720649	zendetejas123@gmail.com	
4	Varpe Prathmesh Kiran	60	7499316693	varpeprathmesh@gmail.com	

Abstract:

Over the years the stock market has been considered a very risky investment by people around the globe. This project aims to understand the historical data of the stock market and derive analysis from it to reduce the gap of knowledge between the market behavior and the investor. A stock data comprises of a lot of statistical terms which are difficult understand by anormal person who wants to step into stock market investments, this project aims at reducing gap of knowledge. In project we attempt to implement machine learning approach to predict stock prices.

Machine learning is effectively implemented in forecasting stock prices. The objective is to predict the stock prices in order to make more informed and accurate investment decisions. Inthis projectwe propose a stock price prediction system that integrates mathematical functions, machine learning, and other external factors for the purpose of achieving better stock prediction accuracy and issuing profitable trades.

In our project, we are using the Time Series Forecasting methodology



KJ's Educational Institute
TRINITY ACADEMY OF ENGINEERING,
PUNE



(Approved by AICTE, New Delhi, Govt. of Maharashtra & affiliated to SPPU, DTE Code: EN6634)

(Accredited by NAAC with 'A' Grade)

Department of Information Technology

for predicting and visualizing the predictions. Our focus for prediction will be based on the technical analysis using historic data and ARIMA Model. Autoregressive Integrated Moving Average (ARIMA) model has been used extensively in the field of finance and economics as it is known to be robust, efficient and has a strong potential for short-term share market prediction.

Keyword: Stock Market, Prediction, Machine Learning, Data Analysis, Times Series Forecasting ,ARMA Model, ARIMA Model, SARIMA Model

